



AIRLESS Spray Gun SERVICE/OPERATION MANUAL



AIRLESSCO - 008 Gun

TABLE OF CONTENTS

SECTION	FIGURE
Introduction	
Safety Warnings 1	1. Gun Safety Latch..... 3
Pressure Relief Procedure 2	2. Gun Components 3
Airless Spray Gun Operation 3	3. Spray Tip 3
Airless Spray Technique..... 4	4. Spray Tip Assembly 3
Tip Selection Guide 6	5. Airless Spray Gun Assembly..... 8
Airless Spray Gun Assembly..... 8	
Troubleshooting & Repairs 9	
Airlessco Accessories 10	

INTRODUCTION



The Airlessco 008 Gun is designed to be very light-weight for all day user comfort. Features include a thumb actuated trigger safety lock and easy-clean filter. The extra large, 3/16" tungsten carbide ball and seat provide BOTH long wear and allow the 008 gun to be used with heavy materials. Uses durable stainless steel (not aluminum) threads for tip attachments and its compact size provides ease of use in tight spaces such as inside cabinetry.

WARNING

**HANDLE THIS UNIT AS YOU WOULD A LOADED FIREARM!
HIGH PRESSURE SPRAY CAN CAUSE EXTREMELY
SERIOUS INJURY. OBSERVE ALL WARNINGS!**

MANUAL NOTATIONS

WARNING - Alerts user to avoid or correct conditions that could cause bodily injury.

CAUTION - Alerts user to avoid or correct conditions that could cause damage to or destruction of equipment.

IMPORTANT - Alerts users to steps or procedures that are essential to proper equipment repair and maintenance.

NOTE - Identifies essential procedures or extra information.

BEFORE OPERATING THIS UNIT, READ AND FOLLOW ALL SAFETY WARNINGS AND INSTRUCTIONS RELATED TO THE USAGE OF THIS EQUIPMENT ON PAGES 1 AND 2. READ, LEARN, AND FOLLOW THE PRESSURE RELIEF PROCEDURE ON PAGE 2 OF THIS MANUAL.

All Service Procedures to be performed by an Authorized Airlessco Service Center **ONLY**.
NO MODIFICATIONS or alterations of any **AIRLESSCO** Equipment or part is allowed.

WARNINGS

INJECTION HAZARD

Fluids under high pressure from spray or leaks can penetrate the skin and cause extremely serious injury, including the need for amputation.

NEVER point spray gun at anyone or at any body part.

NEVER put hand or fingers over the spray tip. Do not use rag or other materials over your fingers. Paint will penetrate through material and into the hand.

NEVER try to stop or deflect leaks with your hand or body.

NEVER wipe off build up around the spray tip.

ALWAYS remove the tip from the gun to clean it, after following the **PRESSURE RELIEF PROCEDURE!**

NEVER operate spray gun under pressure without spray tip

ALWAYS remove tip from the gun to clean it.

NEVER try to "blow back" paint, it's not an air sprayer.

MEDICAL TREATMENT

If any fluid appears to penetrate your skin, get **EMERGENCY CARE AT ONCE.**

DO NOT TREAT AS A SIMPLE CUT.

- Go to an emergency room immediately.
- Tell the doctor you suspect an injection injury.
- Tell him what kind of material you were spraying with and have him call for instructions at **NATIONAL POISON CENTER NETWORK** (412) 681-6669

SPRAY GUN SAFETY

ALWAYS set safety lock on the gun in "**LOCKED**" position when not in use and before servicing or cleaning.

DO NOT remove or modify any part of gun.

CHECK operation of gun safety devices before each use.

NEVER work on gun when connected to hose.

Be very careful when removing hose or spray tip from gun. A plugged line contains fluid under pressure. If tip or line is plugged, follow the Pressure **RELIEF PROCEDURE** for the pump you're using

CLEANING

Refer to pump manufacturer's recommendation for cleaning system. Release pressure from pump and hose, remove spray tip and flush with lowest possible pressure.

GENERAL PRECAUTION

NEVER alter equipment in any manner.

NEVER use around children.

NEVER allow another person to use sprayer.

ALWAYS wear a spray mask while spraying.

NEVER LEAVE SPRAYER UNATTENDED WITH PRESSURE IN THE SYSTEM. FOLLOW PRESSURE RELIEF PROCEDURES ON PAGE 2.

TIP GUARD

NEVER operate gun without tip guard attached.

NEVER modify or alter tip guard.

NEVER use Airlessco tip guard on other attachments.

Airlessco's tip guard is designed for use with standard spray tips only. When using other than standard spray tips, consult manufacturer of such attachment for recommended tip guard & safety instructions.

SPRAY TIP SAFETY

Use extreme caution when cleaning or changing spray tips. If spray tip clogs while spraying, engage gun safety latch.

ALWAYS follow **PRESSURE RELIEF PROCEDURE** before removing spray tip to clean it.

FIRE EXPLOSION WARNING

SPRAYING VAPORS + STATIC SPARKING = FIRE/EXPLOSION

PREVENT FIRE AND EXPLOSION BY REDUCING STATIC SPARKING AND ELIMINATING VAPORS

ALWAYS be sure all equipment, paint bucket and object being sprayed are properly grounded. **ALWAYS** ground sprayer, gun, paint bucket and object being sprayed. Be sure gun is grounded through hose connection.

NEVER spray in closed area. Ventilation must be adequate to remove vapors.

NEVER keep flammable materials in spray area.

NEVER spray highly flammable liquids.

ALWAYS use high pressure conductive hoses with static wire approved for 3000 psi. Never exceed 500 ft. of hose.

NEVER SMOKE IN SPRAYING AREA.

ALWAYS ensure properly maintained fire extinguishing equipment is available.

NEVER spray in vicinity of open flame or other sources of ignition such as water heaters and furnaces.

ALWAYS locate the sprayer and electrical outlets in use at least 25 feet away from spray area in well ventilated area. Do not plug in any electrical cords in spray area. Follow the coating and solvent manufacture's safety precautions and warnings.

HALOGENATED HYDROCARBON WARNING:

NEVER use halogenated hydrocarbon (HHC) solvents or paints that contain them in this system. Some of the most common of these solvents are: Carbontetrachloride, Chlorobenzene, Dichloroethane, Dichloroethyl Ether, Ethyl bromide, Ethylchloride, Tetrachloethane.

FLUSHING AND CLEANING CAN CREATE STATIC SPARKING IF DONE IMPROPERLY!

NEVER spray solvents under pressure through spray tip. Follow **PRESSURE RELIEF PROCEDURE** and remove spray tip for cleaning. Use **LOWEST POSSIBLE PRESSURE** when flushing and cleaning.

Hold gun against metal container to reduce spark chance. **NEVER** use cleaning solvents with flash points below 140 degrees F. Some of these are: acetone, benzene, ether, gasoline, naphtha. Consult your supplier to be sure.

WARNINGS CONTINUED

- High pressure spray can cause extremely serious injuries such as amputation.
- Handle the spray gun as you would a loaded firearm!! Read and understand all instruction manuals, tags, warnings, users guides & labels supplied with the spray gun, airless pump, hoses, spray tips & any other attachments before operating equipment.
- Learn & follow "Pressure Relief Procedure" of the equipment in use. Never attempt to change or clean the spray tip or service unit & gun without first releasing pressure. If "Pressure Relief Procedure" is not known, contact pump manufacturer for instruction.
- Never leave pressure in the system while not in use.
- Airlessco spray guns are designed for use with Airlessco spray tips only.
- If any other attachments are used, the spray gun is considered to be modified and safe operation is now limited to the safety of the attachment.
- For safe renting of airless equipment, use rental instructions, warnings and forms supplied by airless pump manufacturer.
- Be sure that all safety devices are operating properly before each use.

PRESSURE RELIEF PROCEDURE

⚠ IMPORTANT!

TO AVOID POSSIBLE SERIOUS BODY INJURY, ALWAYS FOLLOW THIS PROCEDURE WHENEVER THE SPRAYER IS SHUT OFF, WHEN CHECKING IT, WHEN INSTALLING, CHANGING OR CLEANING TIPS, WHENEVER YOU STOP SPRAYING, OR WHEN YOU ARE INSTRUCTED TO RELIEVE THE PRESSURE. RELIEVING PRESSURE WILL BE DIFFERENT FOR EVERY BRAND OF AIRLESS PAINT SPRAYER, REFER TO THE MANUAL THAT CAME WITH YOUR MACHINE TO RELIEVE PRESSURE. FOR AIRLESSCO BRANDED MACHINES, USE THE PROCEDURE BELOW.

1. Engage the gun safety latch. Refer to the separate instruction manual provided with your gun on its safety features and how to engage safety latch.
2. Turn the unit off.
3. Disengage the gun safety latch and trigger the gun to relieve residual fluid pressure.

HOLD METAL PART OF THE GUN IN CONTACT WITH GROUNDED METAL PAIL. USE MINIMUM PRESSURE !

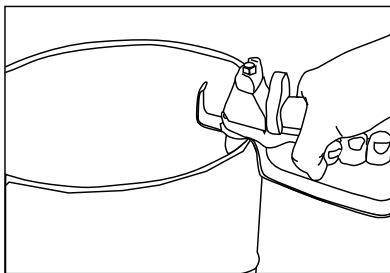

If the **SPRAY TIP OR HOSE IS CLOGGED**, follow Step 1 through 5 above. Expect paint splashing into the bucket while relieving pressure during Step 4.

If you suspect that pressure hasn't been relieved due to damaged Prime/Pressure Relief Valve or other reason, engage the gun safety latch and take your unit to an authorized Airlessco Service Center.

4. On Airlessco Model Paint Sprayers turn Prime/Pressure Relief Valve (PR Valve) to the **OPEN (PRIMING) POSITION TO RELIEVE RESIDUAL FLUID PRESSURE**. (PR Valves on sprayers made by other manufacturers may operate differently.)

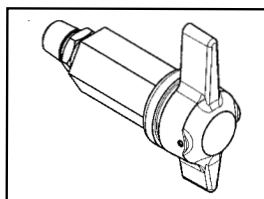

100-180



119-083

100-180: There will be a wider gap between valve handle and cam body when in open position. In the closed position there is only a very slight gap. **NOTE:** The valve handle can move both clockwise and counter clockwise and can face different directions.

5. Re-engage gun safety latch and close Prime/Pressure Relief Valve.

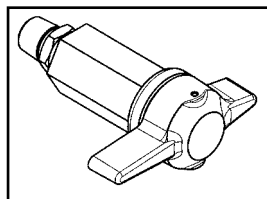

100-180

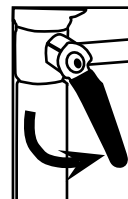

119-083

AIRLESS SPRAY GUN OPERATION

SPRAY

Attach spray gun to airless unit and tighten fittings securely. Set the gun safety latch. (Also may be called gun safety lock, or trigger lock)

* The gun safety latch should always be set when the gun is not being triggered.

Read all warnings and safety precautions supplied with the spray gun and in product manual.

FIG. 1

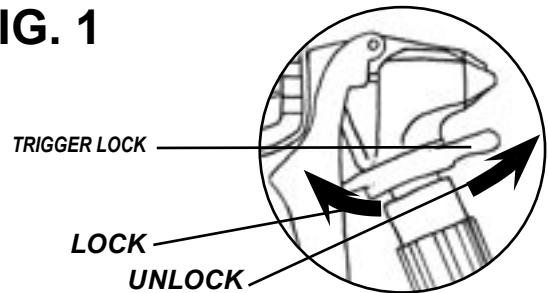

MAJOR COMPONENTS OF SPRAY GUN AND REVERSIBLE SPRAY TIP

FIG. 2



FIG. 3

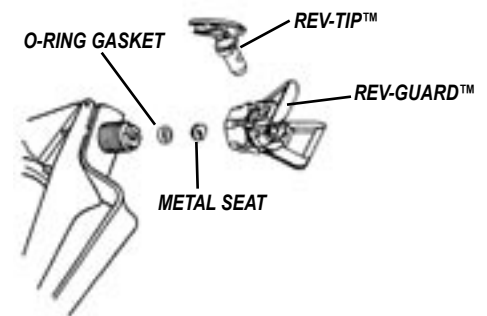

SPRAY TIP ASSEMBLY

1. Be sure **PRESSURE RELIEF PROCEDURE** is followed before assembling tip and housing to the gun.
2. Lock gun safety latch.
3. Insert **REV-TIP™** cylinder into the **REV-GUARD™** (guard housing assembly).
4. Guide metal seat into **REV-GUARD™** (guard housing assembly) through retaining nut & turn until it seats against the cylinder.
5. Insert O-Ring gasket on metal seat so it fits in the grooves.
6. Finger tighten **REV-GUARD™** retaining nut on gun.
7. Turn guard in the desired position.
8. Completely tighten the retaining nut.

FIG. 4

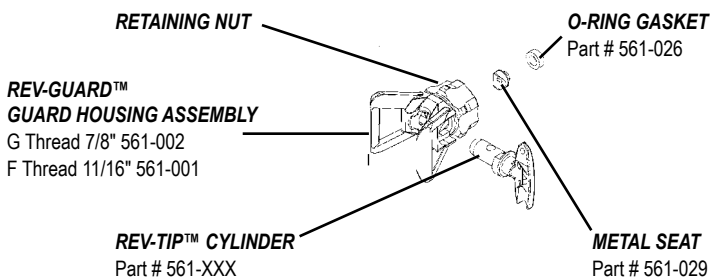

CLEANING SPRAY GUN

Immediately after the work is finished, flush the gun out with a solvent. Brush pins with solvent and oil them lightly so they will not collect dried paint.

CLEANING FILTER IN GUN HANDLE

To clean the filter, use a brush dipped in an appropriate solvent. Change or clean filters at least once a day. Some types of latex may require a filter change after four hours of operation.

TO REMOVE CLOGS FROM SPRAY TIP

1. Lock gun safety latch.
2. Turn **REV-TIP™** handle 180 degrees.
3. Disengage trigger lock & trigger gun into pail.
4. If the **REV-TIP™** handle appears locked (resists turning), loosen the retaining nut. The handle will now turn easily.
5. Engage gun safety latch & return handle to the spray position.

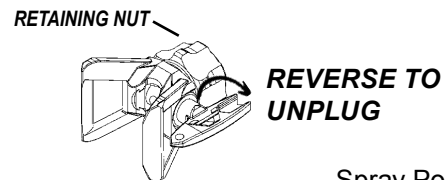

Spray Position Shown

CLOGGED FLAT TIP

Should the spray tip become clogged, relieve pressure from hose by following the **PRESSURE RELIEF PROCEDURE**. Secure gun with the safety latch, take off guard, take out the tip, soak in appropriate solvent & clean with a brush. (Do not use a needle or sharp pointed instrument to clean the tip. The tungsten carbide is brittle and can chip.)

SPRAY TECHNIQUE

Good Spray Gun Technique is at the core of any spray paint operation. Operator skill and efficiency is as important as good equipment and good paint. Good spray technique is a skill that can be quickly learned by following these simple instructions.

If you are not familiar with spraying techniques, we recommend that you study this section of your manual and practice the proper technique on pieces of cardboard or a suitable surface.

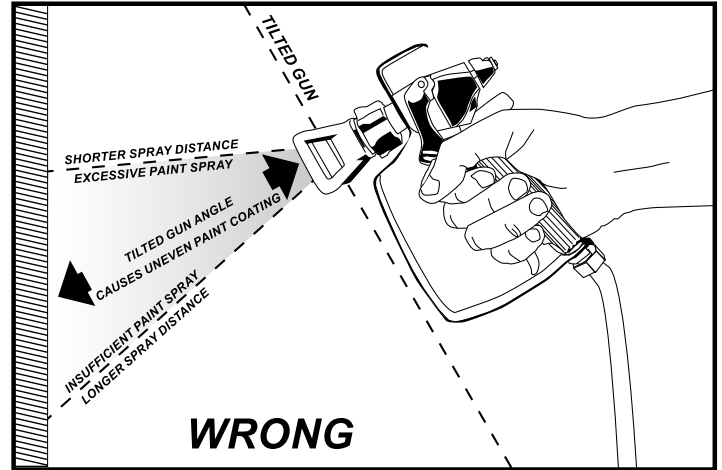
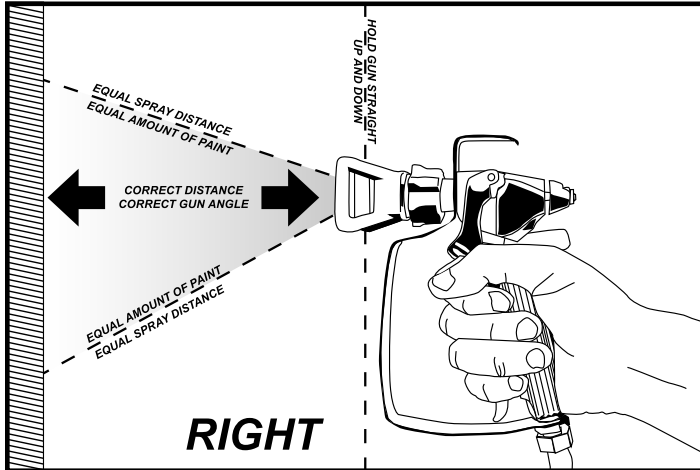

Hold the spray gun 12 - 15 inches away from the work surface and keep it perpendicular (straight) to the surface. Move the spray gun parallel to the work and at a right angle to the surface.

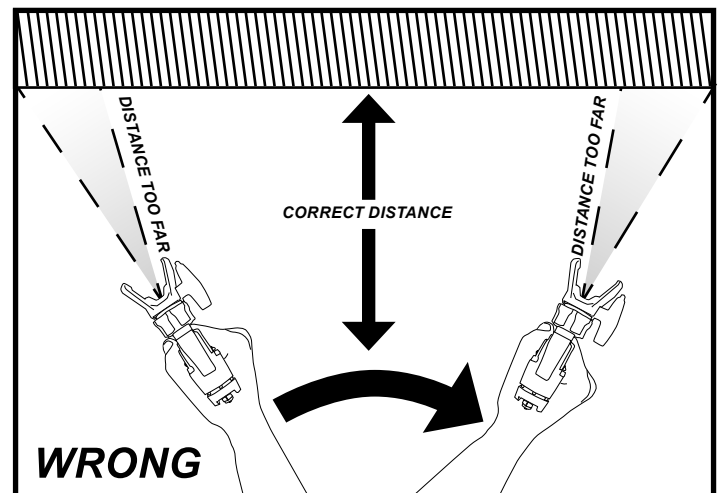
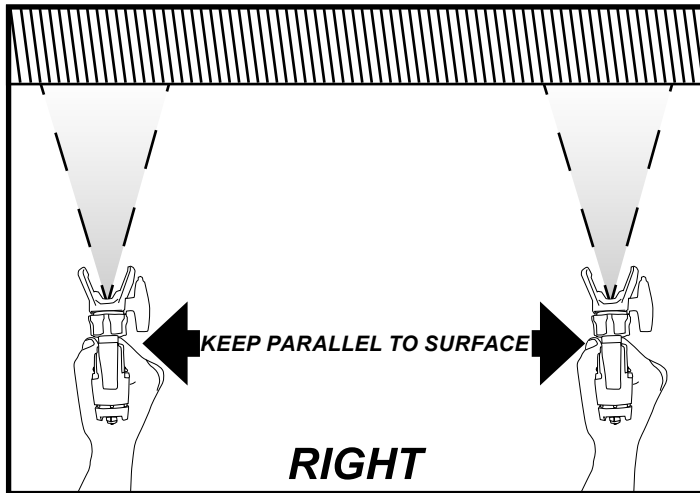

Move the gun at a steady rate in order to apply a good coverage. The wet coat should be just under the thickness at which a run or sag will occur. Slow gun movement or gun held too close will result in an overly wet or thick wet or thick coat coverage that is likely to run or sag.

The closer the spray gun is held to the work, the thicker the paint is deposited and the faster the gun must be moved to prevent sags and runs. Holding the gun too far from the work will cause excessive fog, overspray, and a thin and grainy coat.

Do not wave the spray gun. This waving is called arching. Instead, hold the spray gun at a 12 to 15 inch distance perpendicular from the work.

SPRAY TECHNIQUE

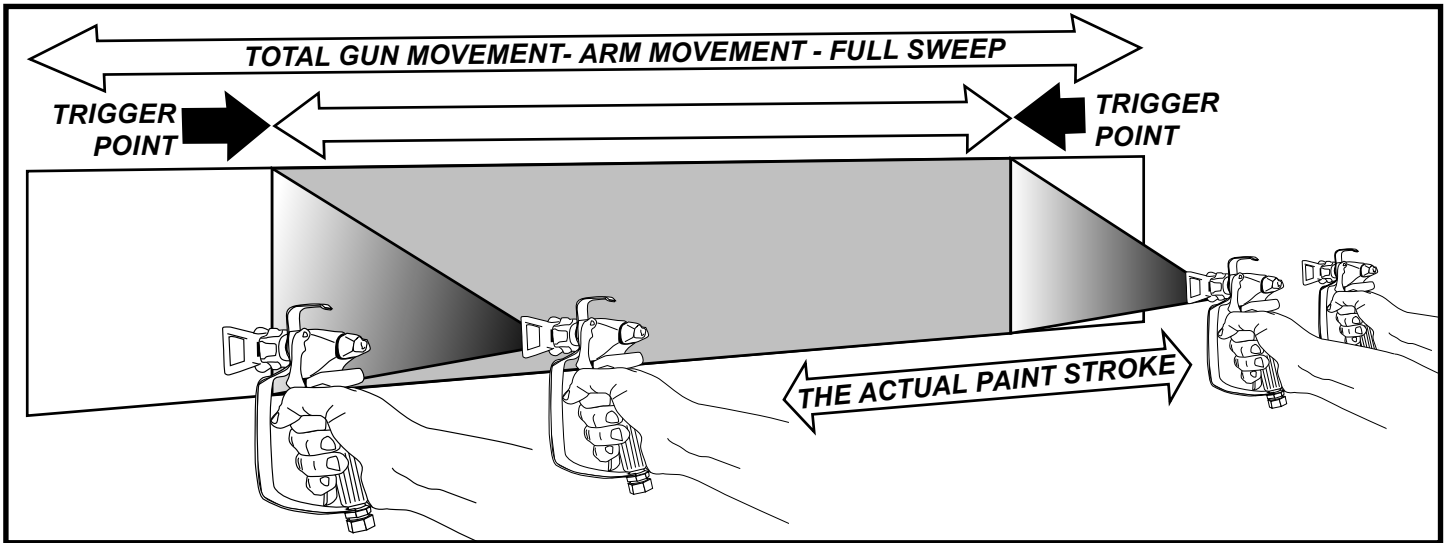

It is important to “trigger” the gun after gun movement (arm movement) has started and release trigger (shut gun off) before gun movement ends. Gun movement is always longer than actual paint (spray) stroke. In that manner, even blending and uniform paint coat thickness is achieved over the entire surface. When the gun is in motion as the trigger is pulled, it deposits an even amount of paint.

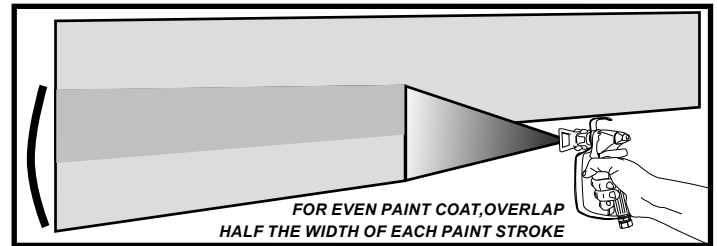

Overlap the previous pass by half the width of the spray pattern. Aim at the bottom of the previous pass.

Spray with uniform strokes from left to right and from right to left, holding stroke speed, distance, lapping, and triggering as uniform as possible.

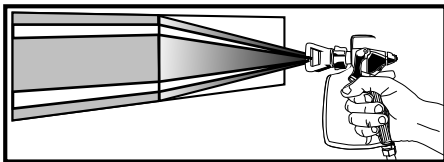

TAILING

Adjust pressure control knob so that paint is completely atomized from the spray gun. Insufficient pressure will result in “tailing. Too much pressure will result in excessive

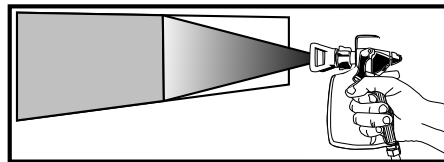

GOOD PATTERN

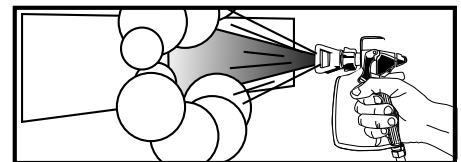

FOG, OVERSPRAY

fog and overspray, excessive tip wear, and increased sprayer wear and tear.



Always use the lowest pressure possible to obtain desirable results.

Test the spray pattern on a piece of cardboard or other surface.

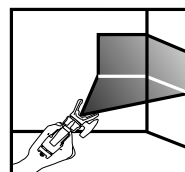

INSIDE CORNER

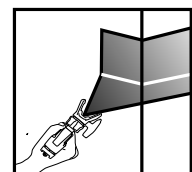

OUTSIDE CORNER

“Inside” and “outside” corners can be sprayed.

Aim the spray gun toward the center of the corner. The spray pattern is divided in half and the edges of the spray pattern on both walls are the same.

TIP SELECTION GUIDE

Your Airlessco 008 airless spray gun can be used to spray a wide range of coatings. These coatings fall into three general categories: architectural/industrial, line striping, and fine finishing. Each of these categories uses a different style of tip. The line striping tips differ from standard tips as they are machined to spray heavier on the edges of the pattern to create crisper lines. The fine finish tips have double orifices to better atomize light-weight coatings, such as lacquers. All three styles of **REV-TIP™** tips use the same **REV-GUARD™** base. Each **REV-TIP™** style is color coded to ease identification, with standard rev-tips being blue, line striping, orange, and fine finish, green.

TIP IDENTIFICATION

1ST 3-DIGITS identifies it as a **REV-TIP™** for airless paint spraying (P.N. 560-xxx), a **REV-TIP™** for airless line striping (P.N. 562-xxxST), or a **REV-TIP™** for fine finishing (P.N. 571-xxx)

4TH DIGIT is the fan width - the number is half the fan width, e.g., 5 means a 10" fan, when 12" from the substrate. Exception are the "W" prefix tips which indicate a wide spray pattern.

5TH AND 6TH DIGITS are for the orifice size, which is measured in thousandths of an inch, e.g., 17 = 0.017 inch - The higher the number, the larger the tip. Orifice size is important as it is matched up to the type of coating to be sprayed, e.g. 11 for clear coats, 17 for latex paints, and 25 for some elastomerics.

NOTE: Tips are a wear item. For example, a .017 tip spraying latex paint can wear to a .019 orifice in as little as 50 gallons, then to a .021 after another 50 gallons. As this happens, the fan pattern starts to become more circular, until the edges start to finger. On smaller volume (GPM) airless paint sprayers, a tip can become so large that the unit can no longer maintain good spray pressure.

REV-TIP™ FOR STRIPING 562-XXXST

FAN WIDTH (6" FROM SURFACE)		ORIFICE SIZE (INCHES)				
Inches	Millimeters	.013	.015	.017	.019	.021
1-2	25-51	113ST	115ST	117ST		
2-4	51-102		215ST	217ST	219ST	221ST
4-6	102-152		315ST	317ST	319ST	321ST
6-8	152-203		415ST	417ST	419ST	421ST
Striping paint		Oil Base	Oil Base	Latex	Latex	Latex

FINE FINISH REV-TIP™ 571-XXX

FAN WIDTH (6" FROM SURFACE)		ORIFICE SIZE (INCHES)	
Inches	Millimeters	.012	.014
4-6	102-152	212	214
6-8	152-203	312	314
8-10	203-254	412	414

TIP SELECTION GUIDE

REV-TIP™ for Painting (560-XXX)
Fan Width (12" from surface)

SPRAY TIP - ORIFICE SIZE (INCHES)

in.	mm	.007	.009	.011	.013	.015	.017	.019	.021	.023	.025	.027	.029	.031	.035	.039	.041	
4-6	102-152		209	211	213	215	217	219	221	223	225	227	229					
6-8	152-203	307	309	311	313	315	317	319	321	323	325	327		335				
8-10	203-254		409	411	413	415	417	419	421	423	425	427	431					
10-12	254-305			511	513	515	517	519	521	523	525	527	531	535				
12-14	305-356				613	615	617	619	621	623	625	627	631	635	639	641		
14-16	356-406					715	717		721						739	741		
16-18	406-457					815		819	821				831					
20-24	508-610		NEW WIDE TIPS:						W21	W23	W25	W28	W29	W31				
Gun Filter	C=course-60 mesh F=Fine-100 mesh	F	F	F	F,C	C	C	C	C	C	REMOVE FILTER							
Wood Interior	Lacquer, Varnish, Stain, Sealer, Enamel	•	•	•	•	•												
Wood Exterior	Exterior Stain, Vinyl, Acrylic, Latex				•	•	•	•										
Masonry	Vinyl, Oil Base, Alkyd, Latex, Acrylic, Block Filler, Elastomer					•	•	•	•	•	•	•	•	•	•	•	•	
Ceiling	Hi Build, Mil White								•	•								
Structural Steel	Heavy Coatings								•	•	•	•	•	•	•	•	•	
Water Flow Rate @ 2000psi, 138 bar	(gpm) (lpm)			.12 .49	.18 .69	.24 .91	.31 1.17	.38 1.47	.47 1.79	.57 2.15	.67 2.54	.77 2.96	1.03 3.90	1.31 4.98	1.63 6.17	1.80 6.81		
Paint Flow Rate latex paint @ 2000psi, 138 bar/1.36 spec. gr.	(gpm) (lpm)			.10 .38	.15 .57	.21 .79	.27 1.02	.33 1.25	.40 1.51	.49 1.85	.58 2.20	.66 2.50	.88 3.33	1.12 4.24	1.39 5.26	1.54 5.83		
Pump Minimum Output*	(gpm) (lpm)			.25 1.0	.25 1.0	.33 1.25	.40 1.5	.50 1.9	.60 2.3	.75 2.8	.88 3.3	1.0 3.8	1.25 4.7	1.5 5.7	2.0 8.2	2.2 8.2		

*Pump will support tip worn to next larger size.

AIRLESS SPRAY GUN

FIG. 5

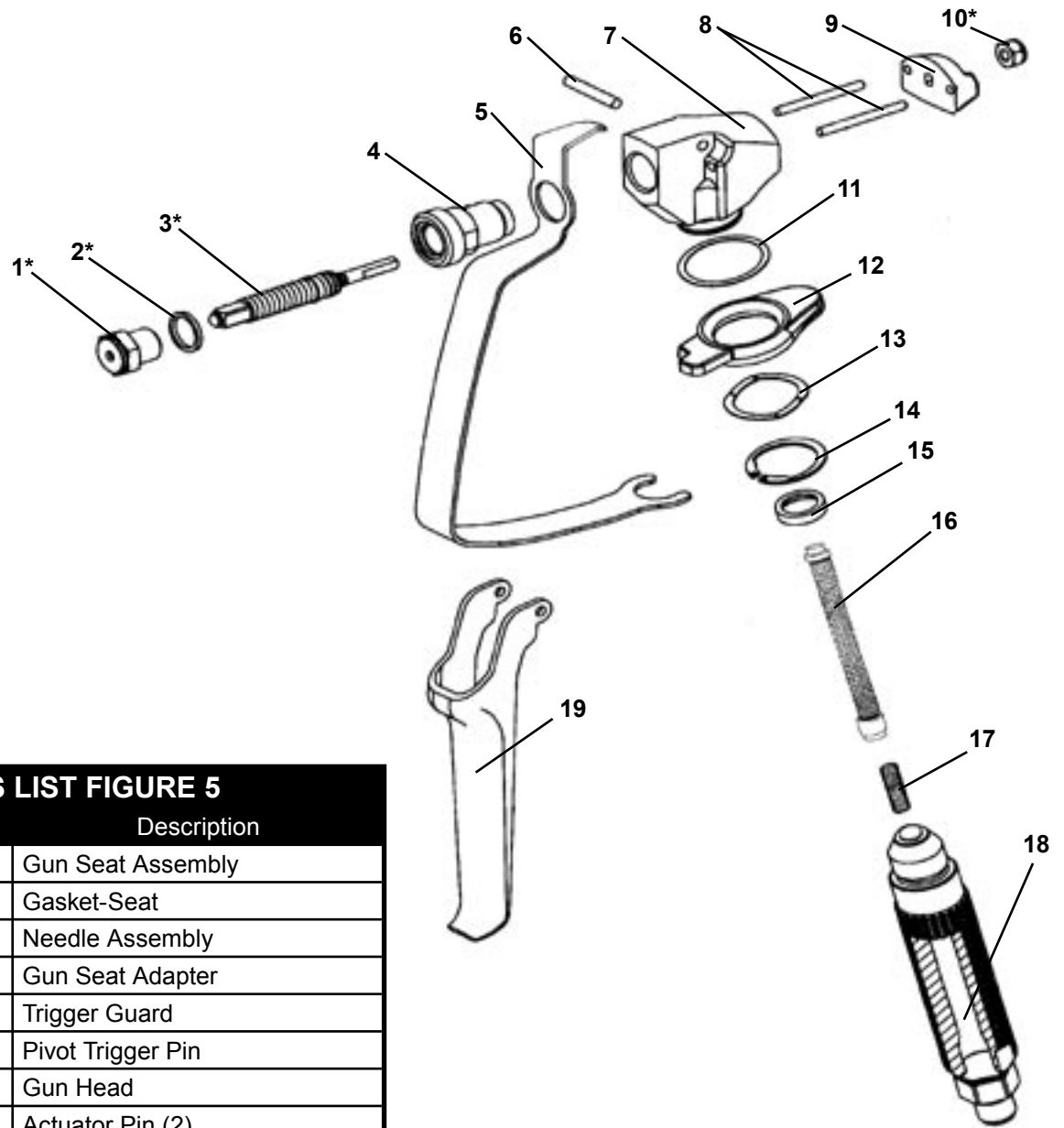

PARTS LIST FIGURE 5

Item No.	Part No.	Description
1	120-530	Gun Seat Assembly
2	120-535	Gasket-Seat
3	120-520	Needle Assembly
4	120-529	Gun Seat Adapter
5	120-562	Trigger Guard
6	120-539	Pivot Trigger Pin
7	120-509	Gun Head
8	120-540	Actuator Pin (2)
9	120-536	Gun Plate
10*	120-038	Nut
11	120-056	Plastic Washer
12	120-538	Gun Trigger Lock
13	120-055	Wave Washer
14	120-049	Retaining Ring
15	120-082	Handle Seal
16	120-090CX	Gun Filter-Coarse
	120-090FX	Gun Filter-Fine
17	120-088	Spring
18	120-099	Gun Handle Assy
19	120-506	Gun Trigger
*	120-534	Gun Repair Kit

TROUBLESHOOTING & REPAIRS

DEFECTS	CAUSE	CORRECTION
Coarse spray	Low pressure	Increase the pressure
Excessive fogging (overspray)	High pressure Material too thin	Reduce the pressure to satisfactory pattern distribution Use less thinner
Pattern too wide	Spray angle too large	Use smaller spray angle tip
Pattern too narrow	Spray angle too small	Use wider spray angle tip
Too much material	Nozzle too large Material too thin Pressure too high	Use smaller orifice Reduce pressure
Too little material	Nozzle too small	Use next larger orifice Material too thick
Thin distribution in center of pattern "horns"	Worn tip Wrong tip	Change to new tip Use nozzle with narrow spray angle
Thick skin on work	Material too viscous Application too heavy	Thin cautiously Reduce pressure and/or use tip in next smaller nozzle group
Coating fails to close & smooth over	Material too viscous	Thin cautiously
Spray pattern irregular, deflected	Orifice clogged Tip damaged	Clean carefully Replace with new tip
Clogged screens	Extraneous material in paint Course pigments	Clean screen Use coarse screen
Excess paint builds on tip guard	Spray gun too close to surface Pressure setting too high	Hold gun further from surface sprayed Reduce pressure setting
Drips, spits from tip	Valve seat and/or ball in gun head damaged or worn	Service spray gun, replace valve assembly
Tip clogs continually	Debris in paint Gun filter missing Coarse filter mesh	Thoroughly strain the paint before use Do not operate without inlet strainer



IMPORTANT NOTE: Whenever working on Airless Equipment, be sure to follow the Pressure Relief Procedure found in your manual. If the gun is attached to a sprayer, engage the gun trigger lock (which may be called the gun safety latch). The gun trigger lock should always be set when the gun is not being triggered.

REPLACING THE VALVE SPRING UNIT

DISMANTLING:

1. Unscrew REV-GUARD™ and remove spray tip & seal.
2. Pulling the trigger, unscrew the Valve Seat using a 5/8" socket wrench.
3. Unscrew the retainer nut, remove the retainer and retainer pins then push the shaft of the valve spring unit out of the gun head.
4. Clean the Gun Head bore with solvent and a small brush. Do not use any sharp objects to scrape away dried paint; doing so may cause damage to the gun head, causing a leak around the seal.

REASSEMBLING:

1. Apply grease to the O-Ring then push valve spring unit firmly into gun head by hand.
2. Reinstall the retainer pins, retainer, and the retainer nut on valve spring unit, tighten the nut until one thread is showing out of the back of the nut.

3. Pull the trigger and install the valve seat by hand until you feel a positive stop.
4. With the trigger locked, and using a feeler gauge (feeler gauge must be placed between the retainer and gun body), tighten the retainer nut so that you have .020" spacing between retainer and gun body.
5. Unlock and depress the trigger, then torque the valve seat to 30 ft. pounds.

REMOVING THE FILTER

1. Push up on the trigger guard, unlocking it from the swivel, then pull away from the gun handle.
2. Grasp the handle of the gun, then turn counter clockwise to loosen from the gun head.
3. Remove the filter from the gun handle and clean or replace as necessary.
4. Re-insert the filter into the gun handle (it will only fit in the proper direction).
5. Re-thread the handle into the gun head until you come to a positive stop. It should be hand tightened only.

Quick Flush™

- The only clean water flushing system
- Cuts sprayer clean-up time in half!
- Connects to standard garden hose to backflush sprayer through gun
- Includes "F" and "G" adapters to work with all brands of gun



Part # **170-005**

PAINT HOPPER

For use on small jobs where paint is kept in smaller than 5 gallon containers. Threads onto pick-up tube of carry or LoBoy framed Airlessco sprayers.

331-775 6 Liter Paint Hopper



PUMP CONDITIONER

Should be used on piston pumps between uses to prevent paint from drying on the piston & causing packing wear.

010-001 Display of 48 - 1 oz. bottles
010-009 1 quart bottle
010-019 1 Gallon bottle

Case quantity: 12 on quarts, 4 on gallons



PAINT STRAINERS

Pre-filter your paint using strainer bags. One dozen per pack.

100-064 Used to cover suction filter
100-065 5 Gallon strainer



HOSE COVER

4 mil poly protects your airless hose from paint and abrasion damage. Comes in 1000' roll with perforations every 50'.

100-219 Hose Cover Roll
100-426 Case of 6 Rolls



HIGH PRESSURE AIRLESS HOSE

Strong yet flexible, for airless sprayers up to 3300 PSI

Part No:	Hose Description
100-012	3/16" Whip Hose, 4 Ft.
100-040	1/4" Whip Hose, 3 Ft.
100-204	1/4" Whip Hose, 5 Ft.
100-199	3/8" Whip Hose, 6 Ft.
100-011	1/4" Hose, 50 Ft.
100-023	3/8" Hose, 50 Ft.
100-037	1/2" Hose, 50 Ft.
100-010	1/4" Hose Connector
100-009	3/8" Hose Connector



STAY CLEAN™

Spray protectant for machine to prevent paint from sticking to it. Keeps your sprayer looking new for years!

114-030 20 oz. can
 Case quantity: 12 cans



THROAT SEAL OIL

Used in the wet cup of a piston pump to prevent paint from drying on the piston & causing damage to the upper packing. Use with all piston pumps.

188-187 6 oz. Bottle
188-392 1 qt. Bottle



XTEND-A-POLE SYSTEM

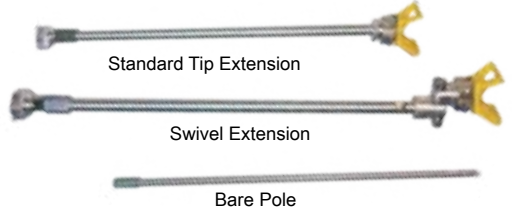

STANDARD TIP EXTENSION, "G" Thread

032-170 6" Long
032-171 12" Long
032-172 18" Long
032-173 24" Long

SWIVEL EXTENSION, "G" Thread

032-184 36" Long

BARE POLE

Add Tip Extension or Swivel Extension to create desired length

032-053 24" Long
032-054 36" Long

SWIVEL "G" THREAD

032-035-55 7/8" x 14 Swivel



ADAPTERS

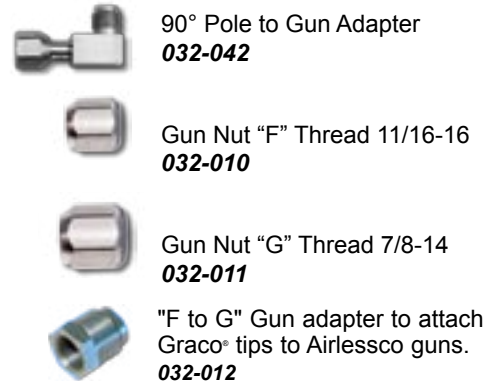

90° Pole to Gun Adapter
032-042

Gun Nut "F" Thread 11/16-16
032-010

Gun Nut "G" Thread 7/8-14
032-011

"F to G" Gun adapter to attach Graco® tips to Airlessco guns.
032-012